



20CTH03
20CTH03S
20CTH03-1
20CTH03FP

Hyperfast Rectifier

Features

- Hyperfast Recovery Time
- Low Forward Voltage Drop
- Low Leakage Current
- 175°C Operating Junction Temperature

$t_{rr} = 35\text{ns max.}$
 $I_{F(AV)} = 20\text{Amp}$
 $V_R = 300\text{V}$

Description/ Applications

International Rectifier's 300V series are the state of the art Hyperfast recovery rectifiers designed with optimized performance of forward voltage drop and Hyperfast recovery time.

The planar structure and the platinum doped life time control guarantee the best overall performance, ruggedness and reliability characteristics.

These devices are intended for use in the output rectification stage of SMPS, UPS, DC-DC converters as well as freewheeling diodes in low voltage inverters and chopper motor drives.

Their extremely optimized stored charge and low recovery current minimize the switching losses and reduce over dissipation in the switching element and snubbers.

Absolute Maximum Ratings

| Parameters | Max | Units |
|-----------------------------------------------------------------------------------------------------------------------------------------|-------------|------------------|
| V_{RRM} Peak Repetitive Reverse Voltage | 300 | V |
| $I_{F(AV)}$ Average Rectified Forward Current @ $T_C = 160^\circ\text{C}$ Per Diode @ $T_C = 135^\circ\text{C}$ (FULLPACK) Per Diode | 10 | A |
| | 20 | |
| I_{FSM} Non Repetitive Peak Surge Current @ $T_J = 25^\circ\text{C}$ | 120 | |
| T_J, T_{STG} Operating Junction and Storage Temperatures | - 65 to 175 | $^\circ\text{C}$ |

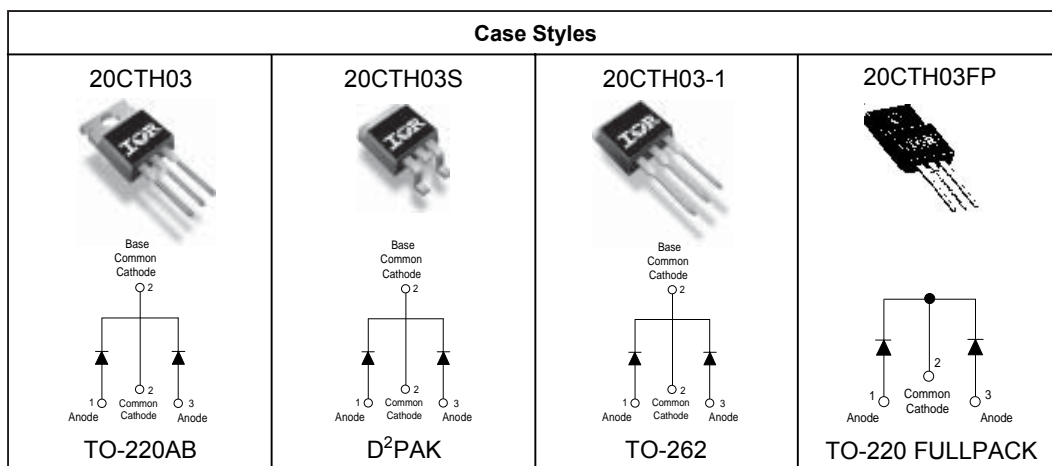

Electrical Characteristics @ T_J = 25°C (unless otherwise specified)

| Parameters | Min | Typ | Max | Units | Test Conditions |
|----------------------------------------------------------------------|-----|------|------|-------|---------------------------------------------------------------|
| V _{BR} , V _F Breakdown Voltage, Blocking Voltage | 300 | - | - | V | I _R = 100μA |
| V _F Forward Voltage | - | 1.05 | 1.25 | V | I _F = 10A, T _J = 25°C |
| | - | 0.85 | 0.95 | V | I _F = 10A, T _J = 125°C |
| I _R Reverse Leakage Current | - | - | 20 | μA | V _R = V _R Rated |
| | - | 6 | 200 | μA | T _J = 125°C, V _R = V _R Rated |
| C _T Junction Capacitance | - | 30 | - | pF | V _R = 300V |
| L _S Series Inductance | - | 8 | - | nH | Measured lead to lead 5mm from package body |

Dynamic Recovery Characteristics @ T_C = 25°C (unless otherwise specified)

| Parameters | Min | Typ | Max | Units | Test Conditions |
|-----------------------------------------|-----|-----|-----|-------|--------------------------------------------------------------------------|
| t _{rr} Reverse Recovery Time | - | - | 35 | ns | I _F = 1A, di _F /dt = 50A/μs, V _R = 30V |
| | - | - | 30 | | I _F = 1A, di _F /dt = 100A/μs, V _R = 30V |
| | - | 31 | - | ns | T _J = 25°C |
| | - | 42 | - | | T _J = 125°C |
| I _{RRM} Peak Recovery Current | - | 2.4 | - | A | T _J = 25°C |
| | - | 5.6 | - | | T _J = 125°C |
| Q _{rr} Reverse Recovery Charge | - | 36 | - | nC | T _J = 25°C |
| | - | 120 | - | | T _J = 125°C |

I_F = 10A
di_F/dt = 200A/μs
V_R = 200V

Thermal - Mechanical Characteristics

| Parameters | Min | Typ | Max | Units |
|--------------------------------------------------------|------|-----|-----|-------|
| T _J Max. Junction Temperature Range | - | - | 175 | °C |
| T _{Stg} Max. Storage Temperature Range | - 65 | - | 175 | |
| R _{thJC} Thermal Resistance, Junction to Case | - | - | 1.5 | °C/W |
| | - | - | 3.9 | |

Per Diode
Fullpack (Per Diode)

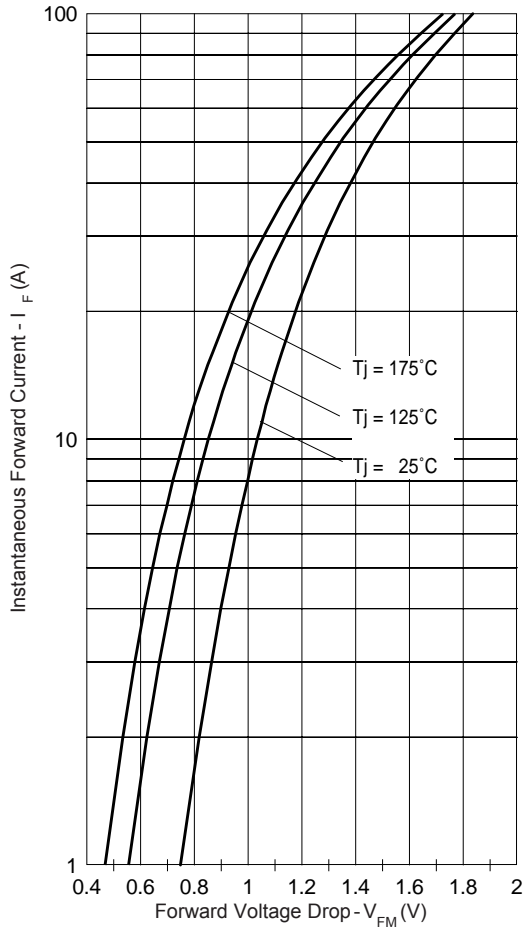

Fig. 1 - Typical Forward Voltage Drop Characteristics

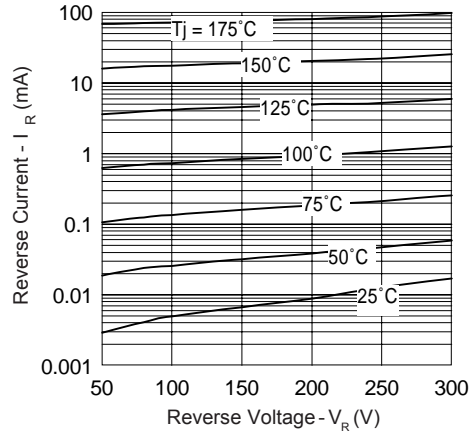

Fig. 2 - Typical Values of Reverse Current Vs. Reverse Voltage

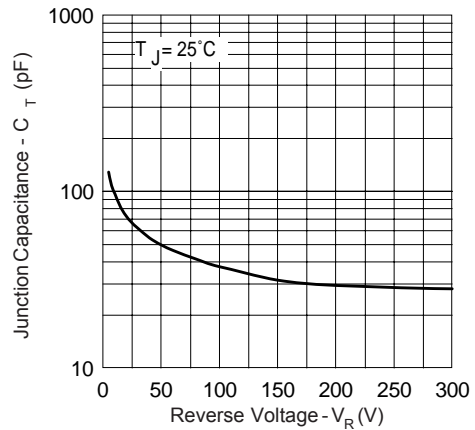

Fig. 3 - Typical Junction Capacitance Vs. Reverse Voltage

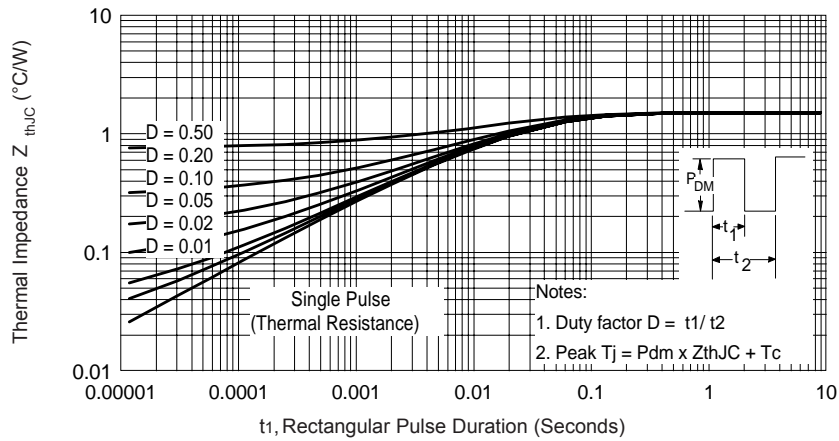

Fig. 4 - Max. Thermal Impedance Z_{thJC} Characteristics

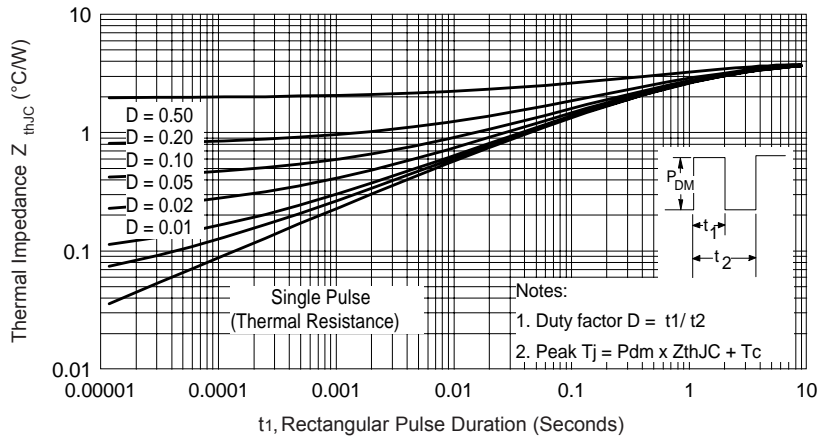

Fig. 5 - Max. Thermal Impedance Z_{thJC} Characteristics (FULLPACK)

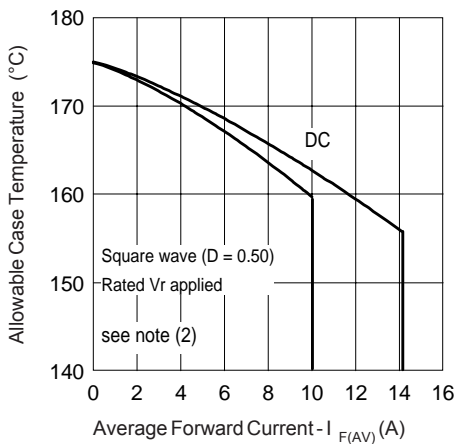

Fig. 6 - Max. Allowable Case Temperature Vs. Average Forward Current

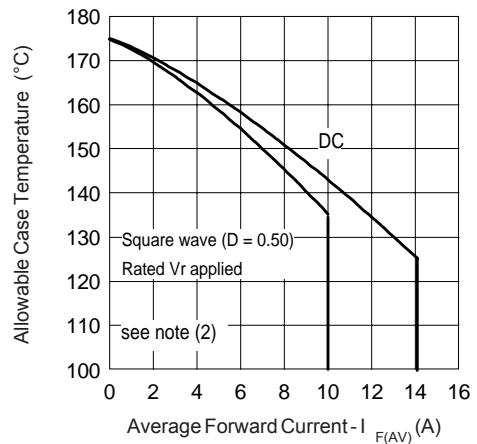

Fig. 7 - Max. Allowable Case Temperature Vs. Average Forward Current (FULLPACK)

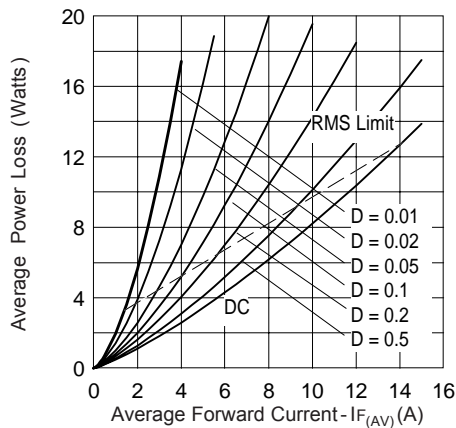

Fig. 8 - Forward Power Loss Characteristics

(2) Formula used: $T_c = T_j - (Pd + Pd_{REV}) \times R_{thJC}$;
 $Pd = \text{Forward Power Loss} = I_{F(AV)} \times V_{FM} @ (I_{F(AV)}/D)$
 (see Fig. 8);
 $Pd_{REV} = \text{Inverse Power Loss} = V_{R1} \times I_R (1-D)$;
 $I_R @ V_{R1} = \text{rated } V_R$

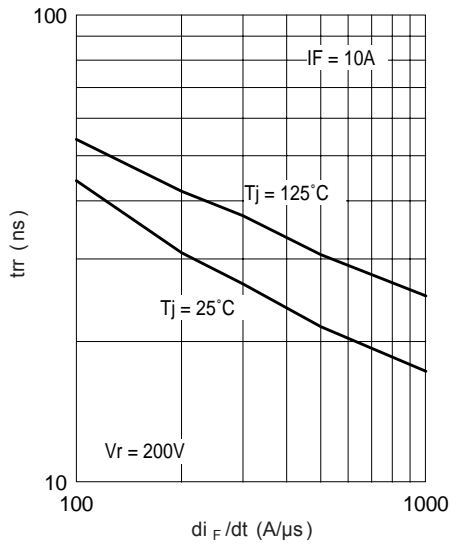

Fig. 9 - Typical Reverse Recovery vs. di_F/dt

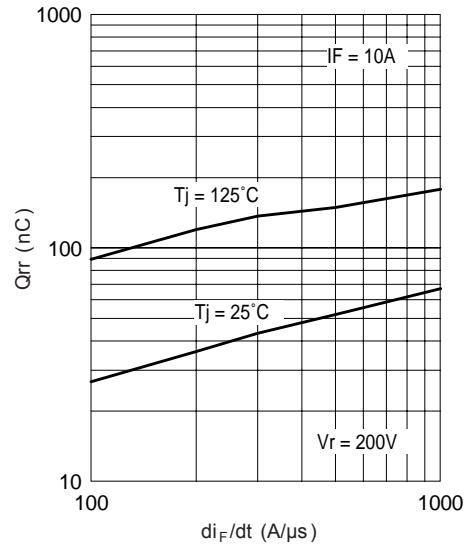

Fig. 10 - Typical Stored Charge vs. di_F/dt

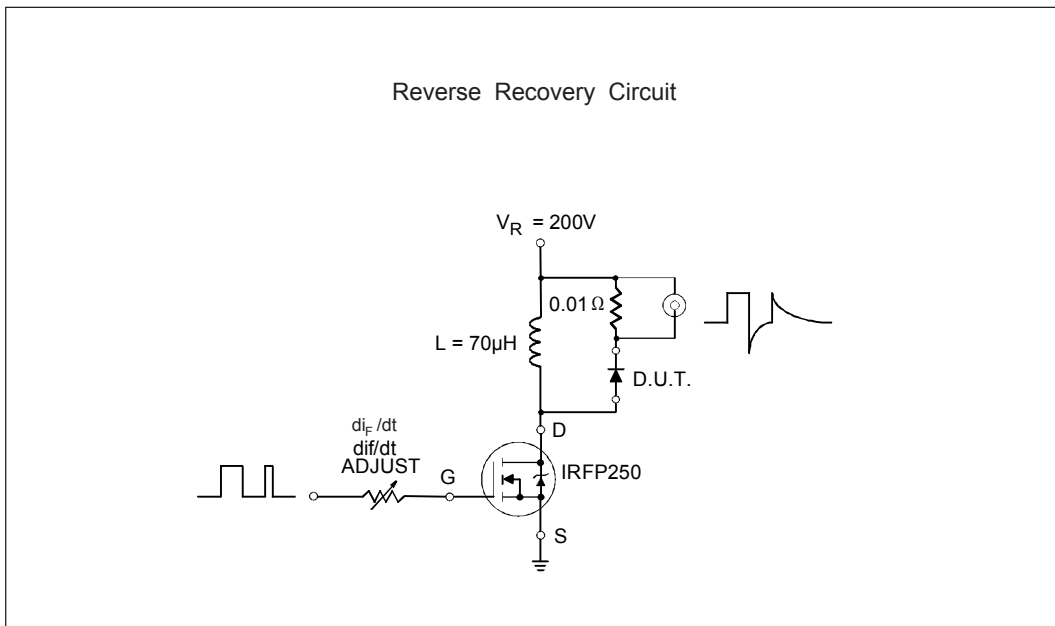
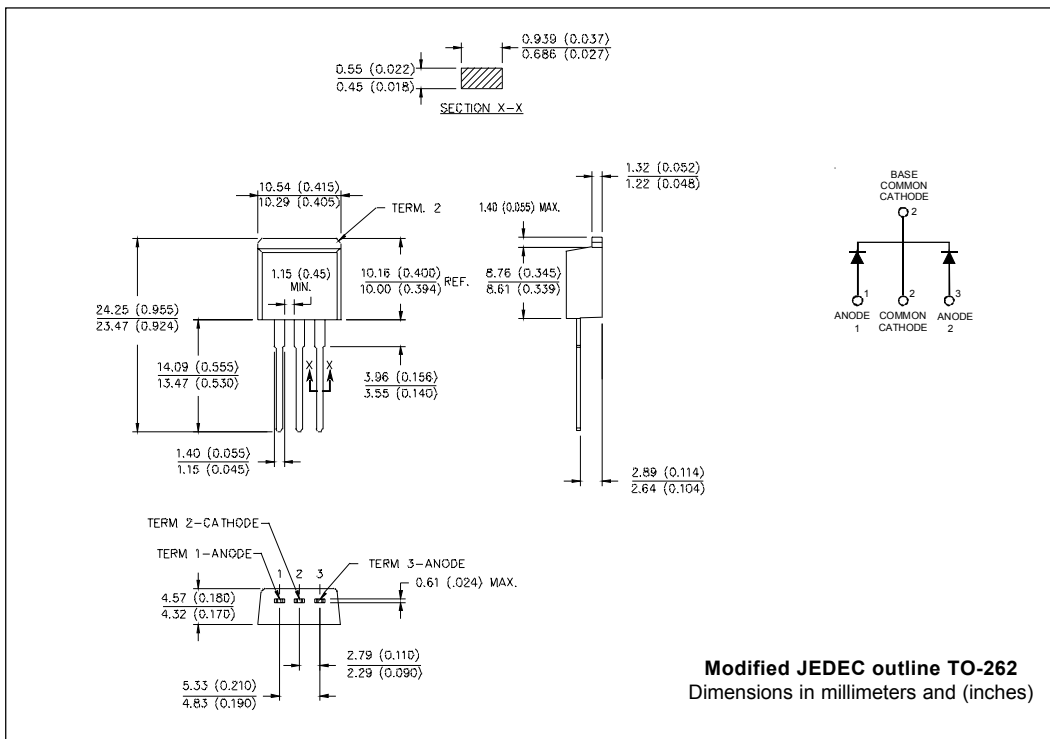
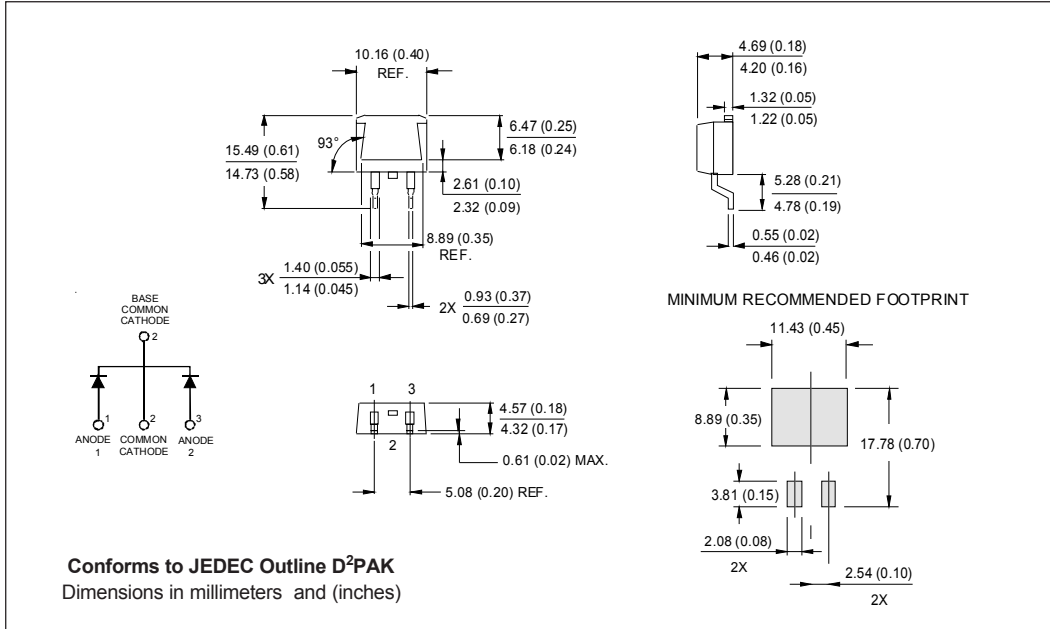
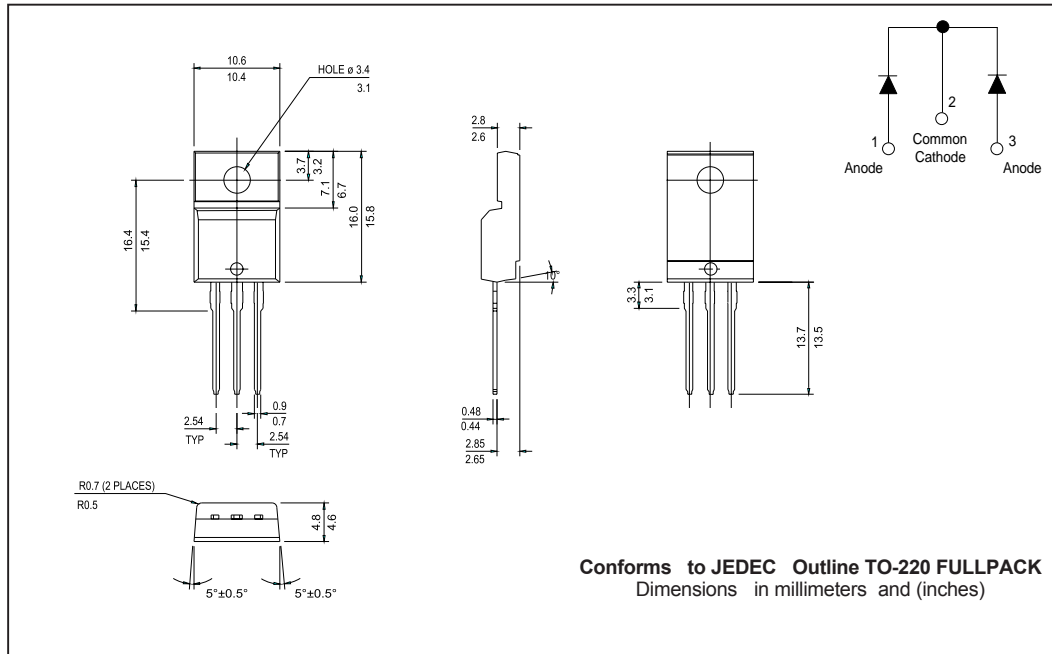

Fig. 11 - Reverse Recovery Parameter Test Circuit

Outline Table



Outline Table



Ordering Information Table

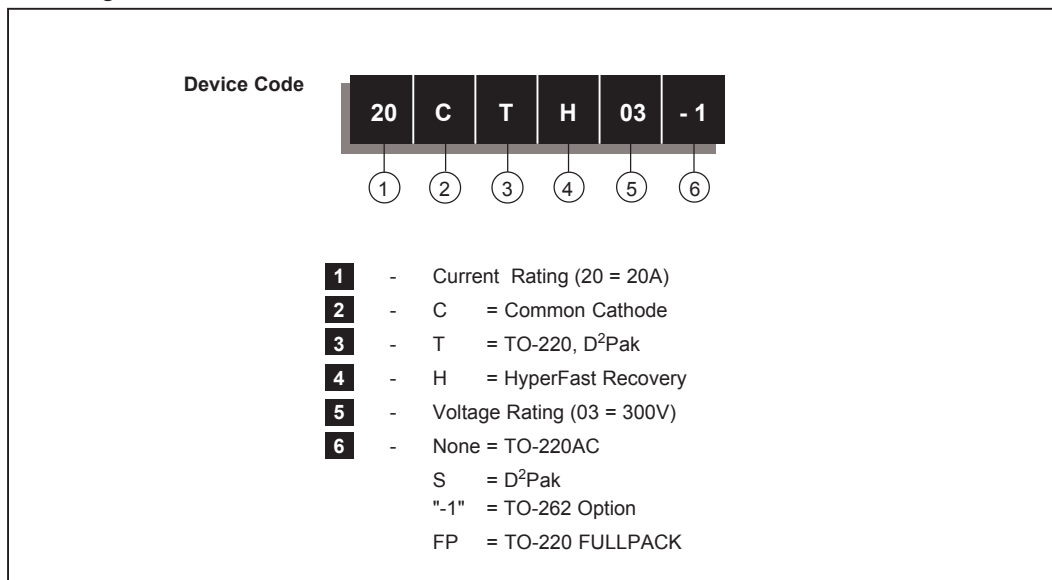

Data and specifications subject to change without notice.
This product has been designed and qualified for Industrial Level.
Qualification Standards can be found on IR's Web site.

International
IOR Rectifier

IR WORLD HEADQUARTERS: 233 Kansas St., El Segundo, California 90245, USA Tel: (310) 252-7105
TAC Fax: (310) 252-7309
Visit us at www.irf.com for sales contact information. 08/03